



# Online Intelligent Soft Starter

ESM-60 series User Manual



<b>Chapter 1 Cautionary Statement</b>	01
1.1 Risk of electric shock	01
1.2 Disposal instructions	03
<b>Chapter 2 Introduction</b>	04
2.1 Function list	04
<b>Chapter 3 Conditions of Use and Installation Requirements</b>	05
3.1 Operating conditions of the online intelligent motor soft starter	05
3.2 The appearance and installation dimensions of the online intelligent motor soft starter	05
<b>Chapter 4 Description of External Terminals of Online Smart Motor Soft Starter</b>	07
<b>Chapter 5 Operation Panel</b>	09
<b>Chapter 6 Basic Parameters</b>	10
<b>Chapter 7 Troubleshooting</b>	14
7.1 Protection response	14
7.2 Trip message	14
<b>Chapter 8 Function Description</b>	16
<b>Chapter 9 Appendix</b>	17
<b>Chapter 10 Modbus Communication Protocol</b>	18
10.1 ModbusRTU Communication Protocol Overview	18
10.2 Support Code	18
10.3 Modbus RTU Communication protocol	18
11.4 Abnormal response	24

## Chapter 1 Cautionary Statement



This symbol is used in this manual to remind readers to attach great importance to special precautions concerning equipment installation and operation.

The caution statement cannot cover every possible cause of equipment damage, but it can emphasize common causes of damage. The installer must read and understand all the instructions in this manual before installing, operating or maintaining the equipment, and must follow effective electrical installation practices (including wearing appropriate personal protective equipment), such as using a method different from that described in this manual. To operate the equipment, advice must be sought in advance.

### Notice



The user cannot repair the soft start. The soft start can only be serviced by authorized service personnel. Unauthorized modification of the soft starter will invalidate the product warranty.

### 1.1 Risk of electric shock

---

There are voltages in the following locations, which may cause serious electric shock accidents and may be fatal:

- AC power cord and connection
- Output wires and connections
- Many parts of starter and external optional equipment

Before opening the starter cover or performing any maintenance work, the AC power supply must be isolated from the starter with an approved isolating device.



Warning-risk of electric shock

As long as the supply voltage is connected (including when the starter is tripped or waiting for a command), the bus and the heat sink must be considered live.



Short circuit

Cannot prevent short circuit. After a severe overload or short circuit occurs, an authorized service agent should fully test the soft start working conditions.



Grounding and branch circuit protection

The user or installer must provide proper grounding and branch circuit protection in accordance with the requirements of local electrical safety regulations.



### For safety

- The stop function of the soft start does not isolate the dangerous voltage at the output of the starter. Before touching the electrical connection, the soft starter must be disconnected with an approved electrical isolation device.
- The soft start protection function is only applicable to motor protection. The user must ensure the safety of machine operators.
- In some installation situations, accidental starting of the machine may endanger the safety of machine operators and may damage the machine. In such cases, it is recommended that you install an isolating switch and circuit breaker (such as a power contractor) that can be controlled by an external safety system (such as emergency stop and fault detection period) on the soft starter power supply.
- The soft starter has a built-in protection mechanism, and the starter trips when a fault occurs to stop the motor. Voltage fluctuations, power outages and motor jams can also cause the motor to trip.
- After eliminating the cause of the shutdown, the motor may restart, which may endanger the safety of some machines or equipment. In this case, proper configuration must be made to prevent the motor from restarting after an unexpected shutdown.
- The soft start is a well-designed component that can be integrated into the electrical system; the system designer/user must ensure that the electrical system is safe and meets the requirements of the corresponding local safety standards.
- If you do not comply with the above recommendations, our company will not bear any responsibility for any damage caused thereby.

## 1.2 Disposal instructions

---



Equipment with electrical parts cannot be treated as domestic waste.

Electrical and electronic waste must be collected separately in accordance with current local laws.

Our company keeps improving products and reserves the right to modify or change product specifications at any time without notice.

The text, diagrams, pictures and any other textual or artistic works in this manual are protected by copyright law. Users can copy some of the materials for personal reference. Without the prior permission of our company, they are not allowed to copy the materials for any other purpose.

Our company tries its best to ensure that the information (including pictures) in this manual is accurate, but does not assume any responsibility for errors, omissions or inconsistencies in the book.

## Chapter 2 Introduction

This soft starter is an advanced digital soft start solution, suitable for motors with power from 5.5kW to 320kW. Provides a complete set of motor and system protection functions to ensure reliable performance even in the harshest installation environment.

### 2.1 Function list

---

#### Optional soft start curve

- Voltage ramp start
- Current limit start
- Torque start

#### Optional soft stop curve

- Free parking
- Timed soft parking

#### Expanded input and output options

- Remote control input
- Relay output
- Analog output
- RS485 communication output

#### Customizable protection

- Input phase loss
- Output phase loss
- Soft start overheating
- Phase sequence
- Running overload
- Starting overcurrent
- Running overcurrent
- Overpressure
- Undervoltage
- Underload

#### Models that meet all connection requirements

- 11A-1260A (rated)  
220VAC-690VAC

#### Easy-to-read display shows comprehensive feedback

- Removable operation panel
- Built-in Chinese + English display

## Chapter 3 Conditions of Use and Installation Requirements

The on-line intelligent motor soft starter should meet the following conditions of use and installation method requirements; otherwise, the performance will not be guaranteed, and in severe cases, the on-line motor soft starter life may be shortened or even damaged.

### 3.1 The use conditions of online intelligent motor soft start:

- Power supply: mains, self-supplied power station, diesel generator set, three-phase AC 220V, 380V, 30Hz to 70Hz, the power supply capacity must meet the starting requirements of the soft starter for the motor.
- Applicable motor: squirrel-cage three-phase asynchronous motor. The rated power of the motor should match the rated power of the on-line intelligent motor soft starter.
- Starting frequency: No requirement, the specific number depends on the load.
- Cooling method: forced air cooling.
- Degree of protection: IP20.
- Environmental conditions: below 2000 meters above sea level, ambient temperature between  $-10^{\circ}\text{C}\sim+40^{\circ}\text{C}$ , relative humidity below 95%RH, no condensation, no flammable, explosive, corrosive gas, no conductive dust, indoor ventilation Good places where the vibration is less than 0.5G. Above 2000 meters above sea level, derating is required.
- The company can provide users with products that are used under special conditions, such as explosion-proof, low-temperature, and high-voltage on-line intelligent motor soft start. The conditions of use will be explained separately.

### 3.2 The appearance and installation dimensions of the online intelligent motor soft starter:

Voltage Level	Rated Working Current	Rated Power	Display Method	Parameter Number	Protect Type	Input Output Number Of Terminals	Overload Capacity
220V	11A-1260A	3kW-350kW	Chinese English LCD	62	12	14	Adjustable
380V	11A-1260A	5.5kW-630kW					
660V	11A-1260A	5.5kW-1000kW					

## Online intelligent motor soft starter

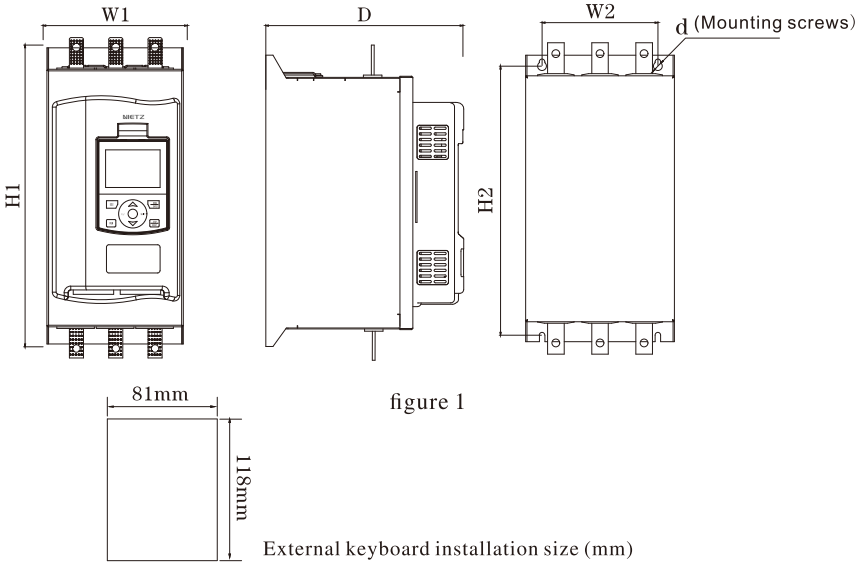

Specification model	Rated current	Horse power	Dimensions (mm)			Installation size (mm)			Outline
			W1	H1	D	W2	H2	d	
5.5KW	11A	7.5HP	145	340	214	85	298	M6	Figure 1
7.5KW	15A	10HP	145	340	214	85	298	M6	
11KW	22A	15HP	145	340	214	85	298	M6	
15KW	30A	20HP	145	340	214	85	298	M6	
18.5KW	37A	25HP	145	340	214	85	298	M6	
22KW	44A	30HP	145	340	214	85	298	M6	
30KW	60A	40HP	145	340	214	85	298	M6	
37KW	74A	50HP	145	340	214	85	298	M6	
45KW	90A	60HP	145	340	214	85	298	M6	
55KW	110A	75HP	172	355	222	140	300	M6	
75KW	150A	100HP	172	355	222	140	300	M6	
90KW	180A	125HP	210	394	255	150	343	M8	
110KW	220A	150HP	210	394	255	150	343	M8	
115KW	230A	155HP	210	394	255	150	343	M8	
132KW	264A	180HP	330	496	265	260	440	M8	
160KW	320A	220HP	330	496	265	260	440	M8	
185KW	370A	250HP	490	608	305	335	542	M8	
200KW	400A	275HP	490	608	305	335	542	M8	
220KW	440A	300HP	490	608	305	335	542	M8	
250KW	500A	340HP	490	608	305	335	542	M8	
280KW	560A	380HP	490	608	305	335	542	M8	
320KW	640A	435HP	490	608	305	335	542	M8	
350KW	700A	475HP	490	608	305	335	542	M8	
400KW	800A	545HP	680	840	418	350	780	M10	
450KW	900A	610HP	680	840	418	350	780	M10	
500KW	1000A	680HP	680	840	418	350	780	M10	
560KW	1120A	760HP	680	840	418	350	780	M10	
630KW	1260A	855HP	680	840	418	350	780	M10	

## Chapter 4 Description of External Terminals of Online Smart Motor Soft Starter

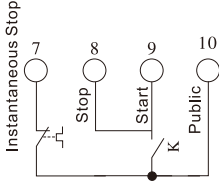

2-wire mode: start when K is closed  
Stop when K is disconnected

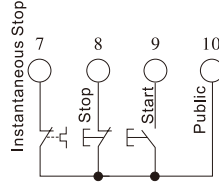

3-wire mode

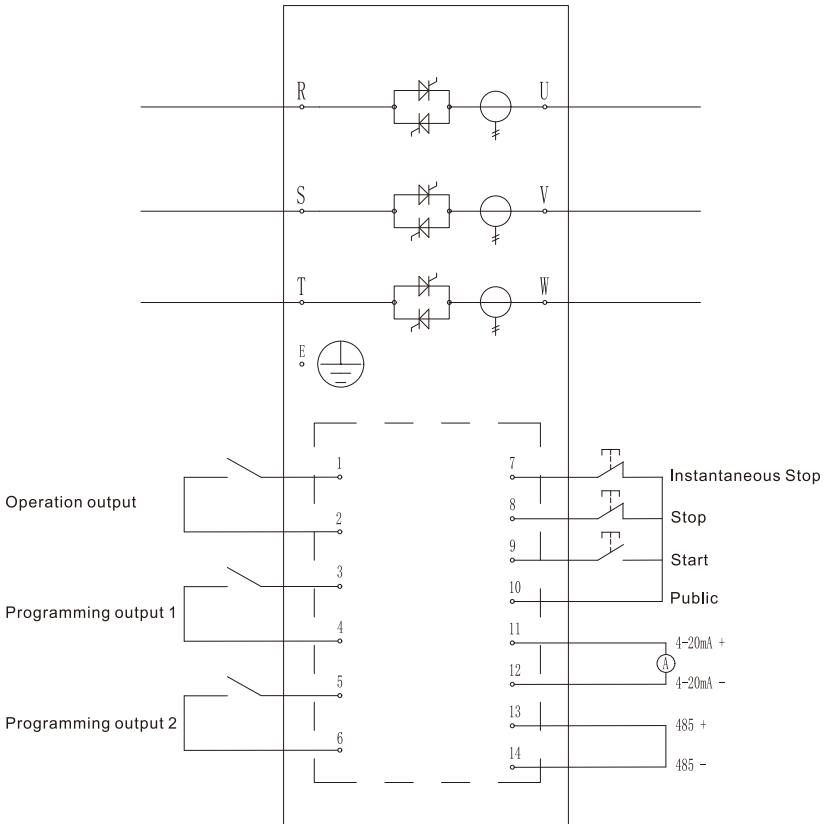

## Online intelligent motor soft starter

Terminal type		Terminal No.	Terminal name	Instruction	
Main circuit		R,S,T	Power Input	Soft start three-phase AC power input	
		U,V,W	Soft Start Output	Connected to three-phase asynchronous motor	
Control loop	Running relay	1	Operation output	Passive contact, closed when starting successfully	
		2			
	Programming Relay 1	3	Programming output 1	Programming output, which can be selected from the following functions: 0: No action 1: Power-on action 2: Soft start action 3: Bypass action 4: Soft stop action 5: Operation action 6: Standby action 7: Fault action 8: Current arrival action	
		4			
	Programming Relay 2	5	Programming output 2		
		6			
	Digital input	7	Instantaneous stop		Instantaneous stop input, soft start is normal to make this composition, and it must be short-circuited with Bazi 10.
		8	stop		Stop terminal
		9	start		Starting terminal
		10	public		Common terminal
	Analog output	11	4-20mA output positive pole	4 - 20mA output	
		12	4-20mA output negative pole		
	485 communication	13	RS485+	For ModBusRTU communication	
		14	RS485-		

## Chapter 5 Operation Panel

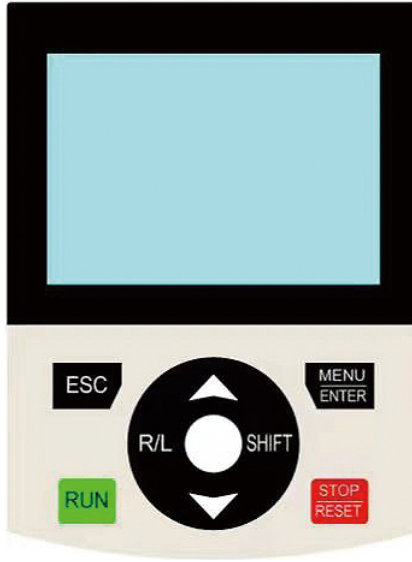

Button	Name	Function
ESC	Cancel key	1. Exit parameters. 2. Cancel modifying parameters
SHIFT	Shift key	1. Shift key when modifying parameters. 2. View the fault record in the main interface.
▲	Increment key	Increment of data and parameter code.
▼	Decrement key	Decrement of data and parameter code.
RUN	Run key	In keyboard operation mode, it is used for operation.
STOP/RESET	Stop/reset button	In operation status, press this key to stop operation; In case of failure, it can be used for reset operation.
MENU/ENTER	Set/Confirm key	1. Enter the parameter menu. 2. Confirm the setting parameters.
R/L	Panel control keys	Turn keyboard control on or off.

## Chapter 6 Basic Parameters

Main item	From item	Set range	Default
A Basic parameters	A00. Control mode	0: Start and stop prohibited 1: Separate keyboard control 2: Independent control by external control 3: Keyboard+external control 4: Communication is controlled separately 5: Keyboard+communication 6: External control+communication 7: Keyboard+external control+communication	3: Keyboard+external control
	A01. Starting mode	0: Voltage ramp start 1: Current-limiting starting 2: Torque starting	0: Voltage ramp start
	A02. Starting current limiting percentage	50%~600%	300%
	A03. Starting voltage percentage	30%~80%	35%
	A04. Starting time	1s~120s	15s
	A05. Stay voltage	60%~85%	65%
	A06. Early acceleration time	1s~10s	5s
	A07. Stay time	1s~120s	10s
	A08. End Ramp Time	1s~10s	3s
	A09. Soft stop time	0s~60s	0s
	A10. Soft starter type	0: Online 1: Bypass type	0: Online
	A11. Programmable relay 1	Function: 0: No action 1: Power-on action 2: Soft start action 3: Bypass action 4: Soft stop action 5: Operation action 6: Standby action 7: Fault action 8: Current arrival action 9: fault(nc) 10: current reached(nc) Delay: 0-600s	5: Operation action
	A12. Programmable output delay 1		0s
	A13. Programmable relay 2		7: Fault action
A14. Programmable output delay 2	0s		

## Online intelligent motor soft starter

Main item	From item	Set range	Default
A Basic parameters	A15. Current arrival	1%~600%	100%
	A16. Return difference of current arrival	1%~100%	20%
	A17. 4-20mA upper limit current	50%~500%	200%
	A18. Motor wiring mode	0: Line type	0: Line type
		1: Inner triangle	
	A19. Mailing address	1-127	1
	A20. Communication baud rate	0:2400 1:4800 2:9600 3:19200	2:9600
	A21. Delay Start Time	0-999	0
	A22. External control mode	0: Pulse mode 1: Level mode	0: Pulse mode
	A23. Display language	0: English 1: Chinese	1: Chinese
A24. Reserved	0	0	

Main item	From item	Set range	Default
B Protection parameters	B00. Operating overload level	1~30	10
	B01. Starting overcurrent multiple	50%-600%	500%
	B02. Starting overcurrent protection time	0s-120s	5s
	B03. Operating overcurrent multiple	50%-600%	200%
	B04. Operation overcurrent protection time	0s-6000s	5s
	B05. Overvoltage protection multiple	100%~140%	120%
	B06. Overvoltage protection time	0s~120s	5s
	B07. Undervoltage protection multiple	50%-100%	80%
	B08. Undervoltage protection time	0s~120s	5s
	B09. Three-phase unbalance	20%~100%	40%
	B10. Three-phase unbalance time	0s~120s	3s
B11. Underload protection multiple	10%~100%	30%	

## Online intelligent motor soft starter

Main item	From item	Set range	Default
	B12. Underload protection time	1s~120s	10s
	B13. Phase sequence selection	0: Any phase sequence 1: Positive phase sequence 2: Reverse phase sequence	0: Any phase sequence

Main item	From item	Set range	Default
C Protection class	C00. Running overload	0: Trip shutdown 1: Ignore	0: Trip shutdown
	C01. Starting overcurrent	0: Trip shutdown 1: Ignore	1: Ignore
	C02. Operation overcurrent	0: Trip shutdown 1: Ignore	0: Trip shutdown
	C03. Overvoltage protection	0: Trip shutdown 1: Ignore	0: Trip shutdown
	C04. Undervoltage protection	0: Trip shutdown 1: Ignore	0: Trip shutdown
	C05. Three-phase unbalance	0: Trip shutdown 1: Ignore	0: Trip shutdown
	C06. Underload	0: Trip shutdown 1: Ignore	1: Ignore
	C07. Soft starter overheat	0: Trip shutdown 1: Ignore	0: Trip shutdown
	C08. Thyristor breakdown emergency	0: Close 1: Open	0: Close
	C09 input phase loss	0: Trip shutdown 1: Ignore	0: Trip shutdown
	C10 output phase loss	0: Trip shutdown 1: Ignore	0: Trip shutdown

Main item	From item	Set range	Default
D Calibration function	D00. A phase current calibration value	10%~1000%	100%
	D01. B phase current calibration value	10%~1000%	100%
	D02. C phase current calibration value	10%~1000%	100%
	D03. Input voltage calibration value	10%~1000%	100%
	D04. Output voltage calibration value	10%~1000%	100%
	D05.4-20mA lower limit calibration	0%~150.0%	20.0%
	D06.4-20mA. Upper limit calibration	0%~150.0%	100.0%

## Online intelligent motor soft starter

Main item	From item	Set range	Default
▣ Status Information	E00. Rated current of soft start		
	E01. Rated voltage of soft start		
	E02. Rated current of motor		
	E03. Average current		
	E04. Input voltage		
	E05. Output voltage		
	E06. Phase A current		
	E07. B phase current		
	E08. C phase current		
	E09. Start completion percentage		
	E10. Three-phase current unbalance		
	E11. Power frequency		
	E12. Power phase sequence	Positive phase sequence/ reverse phase sequence	
	E13. Cumulative running time	0 minutes~10000 days	
E14. Number of starts	0~65535		
E15. Control software version			

## Chapter 7 Troubleshooting

### 7.1 Protection response

When the protection condition is detected, the soft starter writes the protection condition into the program, and it may trip or issue a warning. The soft start response depends on the protection level.

The user cannot adjust some of these protection responses. These trips are usually caused by external events (such as phase loss), and may also be caused by internal faults in the soft start. These trips have no relevant parameters and cannot be set as warning or ignored.

If the soft start trips, you need to identify and clear the conditions that triggered the trip, reset the soft start, and then restart. To reset the starter, press the (stop/reset) button on the operation panel.

### 7.2 Trip message

The following table lists the protection mechanism of soft start and possible trip reasons. Some settings can be adjusted with the protection level, while other settings are built-in system protection and cannot be set or adjusted.

No.	Fault name	Possible Causes	Suggested solution	Remark
01	Input PL	<ol style="list-style-type: none"> <li>1. When the start command is issued, one or more phases of soft start are not powered on.</li> <li>2. The circuit board is faulty.</li> </ol>	<ol style="list-style-type: none"> <li>1. Check whether the main circuit has electricity</li> <li>2. Check whether the SCR of the input circuit is open, and whether the pulse signal line is in poor contact.</li> <li>3. Seek help from the manufacturer.</li> </ol>	Related parameters: C09
02	Output PL	<ol style="list-style-type: none"> <li>1. Whether the SCR is short-circuited.</li> <li>2. One or more phases of the motor wire are open.</li> <li>3. The main board of the circuit board is faulty.</li> </ol>	<ol style="list-style-type: none"> <li>1. Check whether the SCR is short-circuited.</li> <li>2. Check whether the motor wire is open.</li> <li>3. Seek help from the manufacturer.</li> </ol>	Related parameters: C10
03	Running OL	<ol style="list-style-type: none"> <li>1. The load is too heavy.</li> <li>2. Improper parameter settings.</li> </ol>	<ol style="list-style-type: none"> <li>1. Replace the soft starter with more power.</li> <li>2. Adjust the parameters.</li> </ol>	Related parameters: B00, C00

No.	Fault name	Possible Causes	Suggested solution	Remark
04	Under Load	1. The load is too small. 2. Improper parameter settings.	1. Adjust the parameters.	Related parameters: B11, B12, C06
05	SS Over Heat	1. The temperature switch is faulty. 2. The fan does not rotate. 3. The working time of soft start is too long.	1. Check whether the temperature switch is faulty. 2. Check whether the fan is working normally. 3. Stop the machine and let the soft start cool down.	Related parameters: C07
06	Over Volt	1. The input power supply voltage is too high. 2. Improper parameter settings.	1. Check the power supply voltage. 2. Adjust the parameters.	Related parameters: B05, B06, C03
07	Under Volt	1. The input power supply voltage is too low. 2. Improper parameter settings.	1. Check the power supply voltage. 2. Adjust the parameters.	Related parameters: B07, B08, C04
08	Running OC	1. The load is too heavy. 2. Improper parameter settings.	1. Replace the soft starter with more power. 2. Adjust the parameters.	Related parameters: B03, B04, C02
09	Starting OC	1. The load is too heavy. 2. Improper parameter settings.	1. Replace the soft starter with more power. 2. Adjust the parameters.	Related parameters: B01, B02, C01
10	Outside Fault	1. The external fault terminal has input.	1. Check whether there is input at the external terminal.	Related parameters: without
11	Phase Seq Err	1. The input power phase sequence is inconsistent with the setting.	1. Adjust the power phase sequence. 2. Adjust the parameters.	Related parameters: B13
12	Curr Unbalance	1. The power supply voltage is unbalanced. 2. There is a problem with the motor winding. 3. There is a problem with the transformer.	1. Check the power supply voltage. 2. Check the motor winding. 3. Check whether the transformer is open circuit.	Related parameters: B09, B10, C05
13	SCR SC	1. Thyristor breakdown. 2. Circuit board failure.	1. Check whether the thyristor breaks down. 2. Seek help from the manufacturer.	Related parameters: C08

## Chapter 8 Function Description

### Overload protection

Overload protection adopts inverse time limit control

$$\text{Guard time: } t = \frac{35 \cdot T_p}{(I/I_p)^2 - 1}$$

Among them:  $t$  represents the operating time,  $T_p$  represents the protection level,  $I$  represents the operating current,  $I_p$  represents the motor rated current

Motor overload protection characteristic curve: Figure 11-1

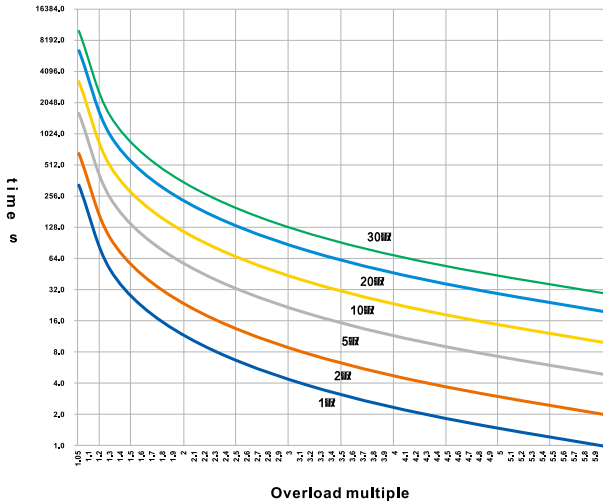

Motor overload protection characteristics

overload level \ overload multiple	1.05I <sub>e</sub>	1.2I <sub>e</sub>	1.5I <sub>e</sub>	2I <sub>e</sub>	3I <sub>e</sub>	4I <sub>e</sub>	5I <sub>e</sub>	6I <sub>e</sub>
1	∞	79.5s	28s	11.7s	4.4s	2.3s	1.5s	1s
2	∞	159s	56s	23.3s	8.8s	4.7s	2.9s	2s
5	∞	398s	140s	58.3s	22s	11.7s	7.3s	5s
10	∞	795.5s	280s	117s	43.8s	23.3s	14.6s	10s
20	∞	1591s	560s	233s	87.5s	46.7s	29.2s	20s
30	∞	2386s	840s	350s	131s	70s	43.8s	30s

∞: Indicates no action

## Chapter 9 Appendix

### Model code

---

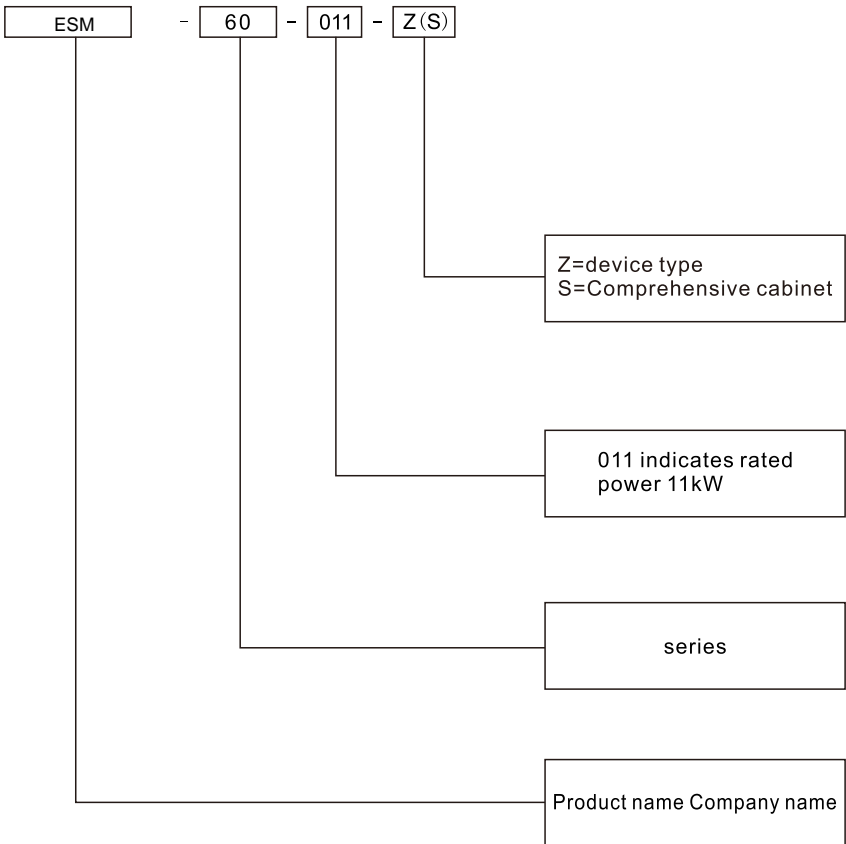

## Chapter 10 Modbus Communication Protocol

### Protocol

#### 10.1 Overview of Modbus RTU Communication Protocol

This series of soft starter provides RS485 communication interface, and supports Modbus-RTU slave communication protocol, users can realize centralized control through calculation or

Electrical interface: RS485 half duplex

Communication parameters: baud rate 9600, 8-bit data bits, no checksum, 1-bit stop bit:

Communication data format

Data Format:	address code	function code	data area	CRC check
Data length:	1 byte	1 byte	N bytes	2 bytes

Soft starter related settings

#### 10.2 Support Code

The soft starter only supports the following codes, if other codes are used, exception codes will be given

code	03	06
functional description	read register	write a single register

Code 03 can only be read with a single word (WORD)

#### 10.3 Modbus RTU communication protocol

Explain:

1. Communication format: no check bit, 8-bit data, 1-bit stop bit.
2. Mailing address: 1~127 optional
3. Communication baud rate: 2400~19200 optional
4. Support modbus function: 03, 06
5. Maximum number of registers transferred at one time: 32

Modbus	Function name	Setting range	Default	Remarks
0	SS Rated Curr			Read
1	SS Rated Volt			Read
2	Mot Rated Curr			R/W
3	Control Mode	0 Disable 1 Keypad 2 Terminal 3 Key+Term 4 Communication 5 Key+Comm 6 Term+Comm 7 Key+Term+Comm	3: Keyboard+ external control	R/W

## Online intelligent motor soft starter

Modbus	Function name	Setting range	Default	Remarks
4	Start Mode	0 Volt Ramp 1 Curr Limnit 2 Torque Start 3 Test Mode	0: Voltage ramp start	R/W
5	CLS Curr Limit	50%~600%	300%	R/W
6	Init Start Volt	30%~80%	35%	R/W
7	VRS Start Time	1s~120s	15s	R/W
8	Stay Volt	60%~85%	65%	R/W
9	Init Ramp Time	1s~10s	5s	R/W
10	Stay Time	1s~120s	10s	R/W
11	End Ramp Time	1s~10s	3s	R/W
12	Soft Stop Time	0s~60s	0s	R/W
13	Soft Starter Type	0: Online 1: Bypass type	1: Bypass type	R/W
14	Program Relay	0 Disable 1 Power On 2 Starting 3 Bypass 4 Stopping 5 Running 6 StandBy 7 Fault 8 Curr Reached	5: Operation action	R/W
15	PR1 Delay Time	0~600s	0s	R/W
16	Program Relay	0 Disable 1 Power On 2 Starting 3 Bypass 4 Stopping 5 Running 6 StandBy 7 Fault 8 Curr Reached	7: Fault action	R/W
17	PR1 Delay Time	0~600s	0s	R/W
18	Curr Reached	1%~600%	100%	R/W
19	Curr Reach Hyst	1%~100%	20%	R/W
20	4~20mA Curr Limit	50%~500%	200%	R/W
21	Motor Wiring	0: Line type 1: Inner triangle	0: Line type	R/W
22	Modbus Addr	1~127	1	R/W

## Online intelligent motor soft starter

Modbus	Function name	Setting range	Default	Remarks
23	Modbus Baundrate	0:2400 1:4800 2:9600 3:19200	2:9600	R/W
24	Running OL Class	1~30	10	R/W
25	Starting OC P.C.	50%-600%	500%	R/W
26	Starting OC Time	0s-120s	5s	R/W
27	Running OC P.C.	50%-600%	200%	R/W
28	Running OC Time	0s-6000s	5s	R/W
29	Over Volt P.C.	100%~140%	120%	R/W
30	Over Vlot Time	0s~120s	5s	R/W
31	Under Volt P.C.	50%-100%	80%	R/W
32	Under Volt Time	0s~120s	5s	R/W
33	Curr Unb P.C.	20%~100%	40%	R/W
34	Curr Unb Time	0s~120s	3s	R/W
35	Under Load P.C.	10%~100%	30%	R/W
36	Under Load Time	1s~120s	10s	R/W
37	Phase Sequence	0: Any phase sequence 1: Positive sequence 2: Reverse phase sequence	0: Any phase sequence	R/W
38	Running OL	0: Trip shutdown 1: Ignore	0: Trip shutdown	R/W
39	Starting OC	0: Trip shutdown 1: Ignore	1: Ignore	R/W
40	Running OC	0: Trip shutdown 1: Ignore	0: Trip shutdown	R/W
41	Over Volt	0: Trip shutdown 1: Ignore	0: Trip shutdown	R/W
42	Under Volt	0: Trip shutdown 1: Ignore	0: Trip shutdown	R/W
43	Curr Unbalance	0: Trip shutdown 1: Ignore	0: Trip shutdown	R/W
44	Under Load	0: Trip shutdown 1: Ignore	1: Ignore	R/W
45	SS Over Temp	0: Trip shutdown 1: Ignore	0: Trip shutdown	R/W
46	SCR SC Start	0: Close 1: Open	0: Off	R/W

## Online intelligent motor soft starter

Modbus	Function name	Setting range	Default	Remarks
47	Reserved			
48	IA Calibration	10%~1000%	100%	R/W
49	IA Calibration	10%~1000%	100%	R/W
50	IA Calibration	10%~1000%	100%	R/W
51	In Volt Cali	10%~1000%	100%	R/W
52	Out Volt Cali	10%~1000%	100%	R/W
53	4~20mA Low Cali	0%~150.0%	20.0%	R/W
54	4~20mA Up Cali	0%~150.0%	100.0%	R/W
55	Display Language	0: English 1: Chinese	1: Chinese	R/W
56	Disp Curr Mode	0 Ave Current 1 Three Phase Curr	0 Ave Current	R/W
57	SS Version			Read
58	Accu Run Second H			Read
59	Accu Run Time			Read
60	SS Start Times			Read
61	Reserved			R/W

### Equipment status

100	SS Status	0:Ready 1:Starting 2:Running 3:Stopping 5:Fault		Read
101	Cur Fault	0:No Fault 1:Input PL 2:Run Input PL 3:Output PL 4:Run Output PL 5:Running OL 6:Start OL 7:Under Load 8:Fast OC 9:Curr Unbalance 10:SS Over Heat 11:Over Volt 12:Under Volt 13:SCR Fault 14:Start Timeout		Read

## Online intelligent motor soft starter

Modbus	Function name	Setting range	Default	Remarks
101	15:Jog Timeout 16:Run OC 17:Start OC 18:Prohibited 19:Mot Over Heat 20:Phase SC 21:Ground SC 22:Outside Fault 23:Over Freq 24:Under Freq 25:Phase Seq Err 26:Curr Hard Err 27:Inner Fault			Read
102	Ave Current			Read
103	Input Volt			Read
104	Output Volt			Read
105	Current A			Read
106	Current B			Read
107	Current C			Read
108	Output Volt P.C.			Read
109	Curr Unb P.C.			Read
110	Apparent Power			Read
111	Power Freq			Read
112	Phase Sequence			Read
113	SS Temp			Read
114	Mot Temp			Read
115	Cur Run Time			Read
116	Accu Run Time			Read
117	Start Times			Read
118	SS Version			Read

## Online intelligent motor soft starter

Modbus	Function name	Setting range	Default	Remarks
<b>Historical fault record</b>				
300	First fault name			Read
301	supply voltage			Read
302	A-phase current			Read
303	Phase B current			Read
304	C-phase current			Read
305	Cumulative running time			Read
306	Second fault name			Read
307	supply voltage			Read
308	A-phase current			Read
309	Phase B current			Read
310	C-phase current			Read
311	Cumulative running time			Read
312	Name of the third fault			Read
...	...			Read
354	Name of the tenth fault			Read
355	supply voltage			Read
356	A-phase current			Read
357	Phase B current			Read
358	C-phase current			Read
359	Cumulative running time			Read
<b>Control Command</b>				
406	Control command register	0x0001 Start 0x0002 Reserved 0x0003 Stop 0x0004 Fault reset		Write

### 10.4 Abnormal response

code	name	illustrate
01	illegal function	Function code soft starter not supported
02	illegal data address	Illegal address, cannot execute
03	illegal data value	Received data cannot be executed: 1: The parameters exceed the space 2: Parameters cannot be modified 3: During runtime, parameters cannot be modified



Notice:

- The communication address, communication speed and verification mode of the soft starter must be the same as the communication settings of the controller.
- If the response data cannot be received, please check the above parameter settings and whether the terminal connection is correct.
- When communicating with multiple soft starters, 120 ohm resistors should be connected to both ends of the last 485+ and 485- terminals.
- When connecting with other MODE BUS devices, it should be connected as shown below:

